

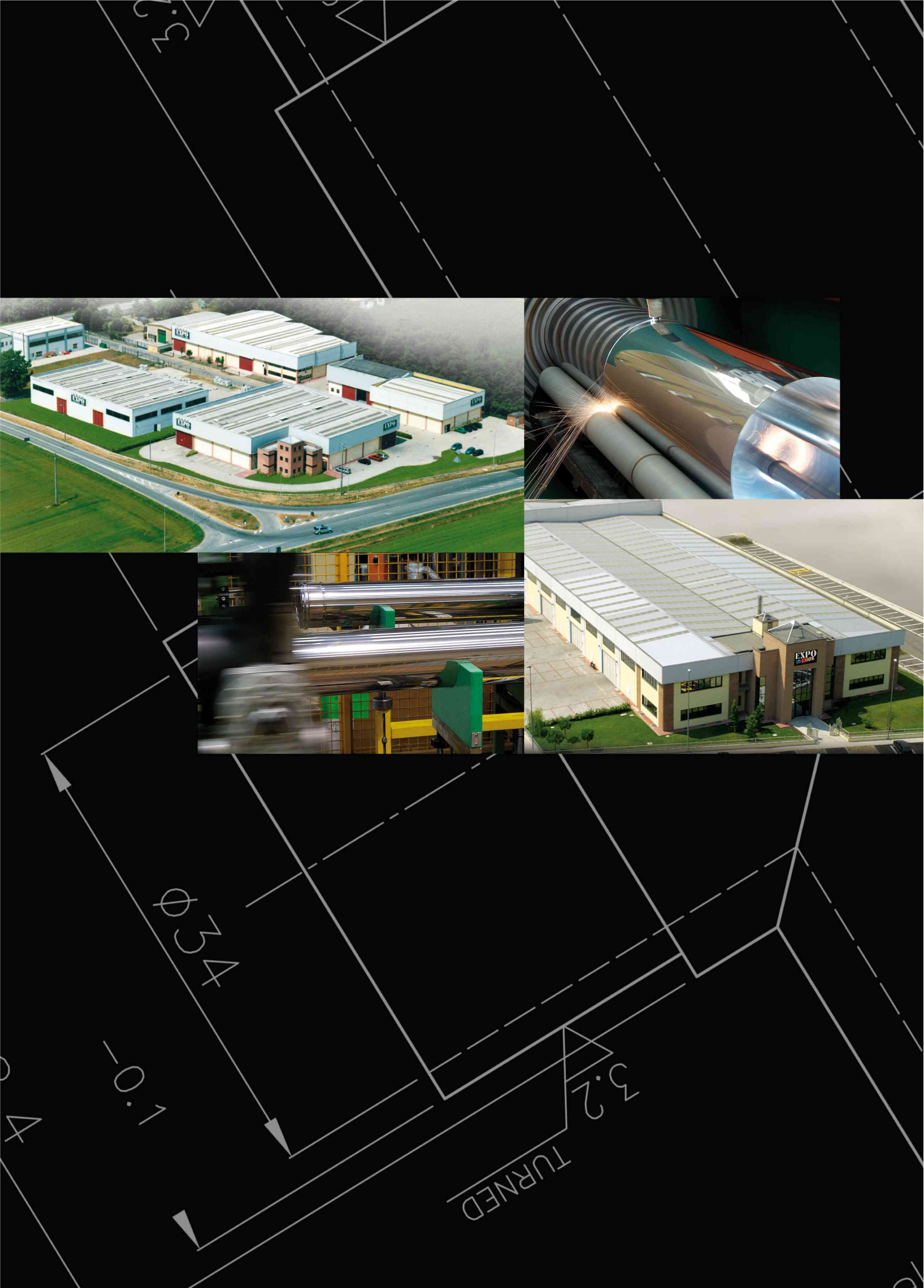

FLEX

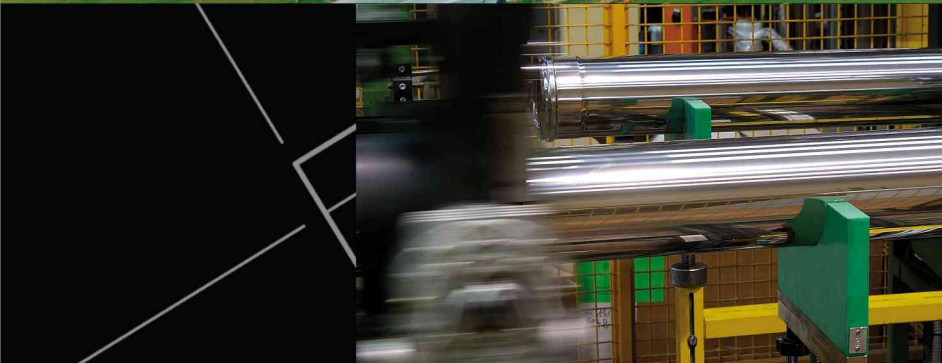

ACÉLA HÁZBAN

EXPO INOX hosszú ideje saválló acél gyártással és feldolgozással foglalkozik. Minden megkeresést pontos tervezés követ; termékeink innovatív technológiája, sokoldalúsága és az anyagok hosszú élettartama tesz minket képessé arra, hogy fejlett műszaki tartalommal, esztétikus termékeket nyújtsunk a legmagasabb minőségben. A rozsdamentes acél ideális az egyszerű vagy éppen összetettebb design megalkotására, beléllszkedve a meglévő környezetbe. Az acéllal történő tervezés az elvárt eredményt nyújtja vásárlóinknak, legyen szó akár a legkifinomultabb kérésről - ez a mi filozófiánk.

BUILDING WITH STAINLESS STEEL

EXPO INOX has been involved in stainless steel production for a long time. Every request is subjected to an accurate planning; the innovative techniques of our products, the multi purpose nature and long lasting characteristics of this material, enable us to propose advanced technical, aesthetical and design solutions of the highest quality. Stainless steel is ideal for linear and essential design creations, matching and respecting the environment in which it is placed. Design with stainless steel, give the customer the result he desires even to the most demanding requests: this is our main objective.

EXPO INOX



67.6

20





Flex és kiegészítők

FLEX AND ACCESSORIES

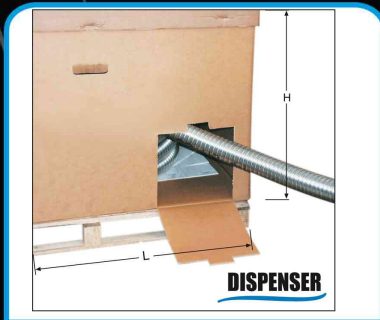

316EXPS..



Egyfalú, flexibilis béléscső AISI 316L

Single wall flexible liner in stainless steel AISI 316L



316EXDP..



Duplafalú, flexibilis béléscső AISI 316L

Twin wall smooth inner surface flexible liner in stainless steel AISI 316L

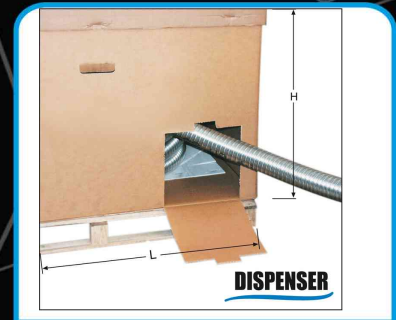

904EXDP..



Duplafalú, flexibilis béléscső AISI 904L

Twin wall smooth inner surface flexible liner in stainless steel AISI 904L

Øi	Øe	Lpl	Hpl	M	Lam	Ham	M.	Ldisp	Hdisp	M..
60	66	-	-	-	-	-	-	-	-	-
73	79	-	-	-	-	-	-	-	-	-
80	86	66	100	30	66	100	30	120	80	60
90	-	-	-	-	-	-	-	-	-	-
100	106	92	72	30	92	72	30	120	80	60
110	116	100	80	30	100	80	30	120	80	60
120	126	100	80	30	100	80	30	120	120	50
125	131	120	80	30	120	80	30	120	120	50
130	136	120	80	30	120	80	30	120	120	50
140	146	120	80	30	120	80	30	120	120	35
150	156	135	70	30	120	120	30	120	150	30
155	161	135	70	30	120	120	30	120	120	30
160	166	135	70	30	120	120	30	120	120	27
180	186	120	120	30	160	70	30	120	120	25
200	206	165	85	25	120	135	25	120	120	20
220	226	160	85	25	165	85	25	-	-	-
225	231	-	-	25	-	-	25	-	-	-
250	256	165	85	20	165	85	20	-	-	-
300	306	6	-	6	-	-	6	-	-	-
350	356	-	-	-	-	-	-	-	-	-
400	406	-	-	-	-	-	-	-	-	-



Flex és kiegészítők

FLEX AND ACCESSORIES



L316EXGM..

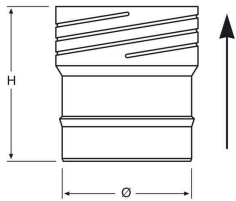

Flex - fix átalakító - apa

Flexadapter to rigid male

Ø	H
80	138
100	138
110	138
120	138
125	138
130	138
140	138
150	138
160	138
180	138
200	138
220	138
250	138
300	138



L316EXGF..

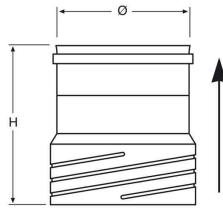

Flex-fix átalakító - anya

Flexadapter to rigid female

Ø	H
80	135
100	135
110	135
120	135
125	135
130	135
140	135
150	135
160	135
180	135
200	135
220	135
250	135
300	135



L316EXFF..

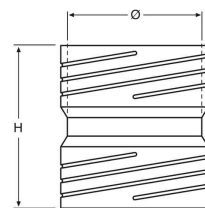

Flex-flex összekötő

Flex - flex joiner

Ø	H
80	137
100	137
110	137
120	137
125	137
130	137
140	137
150	137
160	137
180	137
200	137
220	137
250	137
300	137



Flex és kiegészítők

FLEX AND ACCESSORIES



L316EXFX..

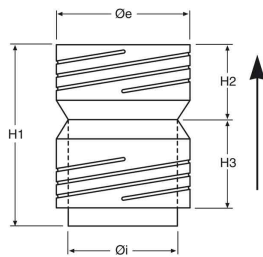

Flex-flex összekötő, nedves üzemre

Flex - flex joiner with condensate diverter

Øe	Øi	H1	H2	H3
86	78	163	73	67
106	98	163	73	67
116	108	163	73	67
126	118	163	73	67
131	123	163	73	67
136	128	163	73	67
146	138	163	73	67
156	148	163	73	67
166	158	163	73	67
186	178	163	73	67
206	198	163	73	67
226	218	163	73	67
256	248	163	73	67
306	298	163	73	67



L316EXMX..

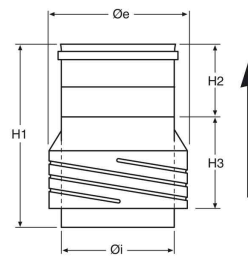

Flex-merev, egyfalú összekötő elem (anya), nedves üzemre

Flexadapter to rigid female with condensate diverter

Øe	Øi	H1	H2	H3
80	78	161	73	67
100	98	161	73	67
110	108	161	73	67
120	118	161	73	67
125	123	161	73	67
130	128	161	73	67
140	138	161	73	67
150	148	161	73	67
160	158	161	73	67
180	178	161	73	67
200	198	161	73	67
220	218	161	73	67
250	248	161	73	67
300	298	161	73	67

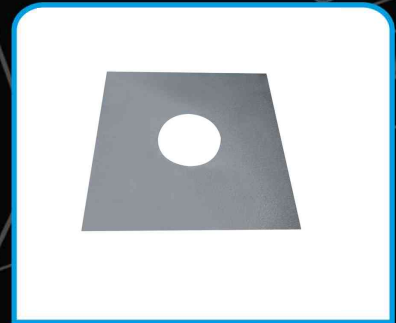

L316EXPIAFLEX..

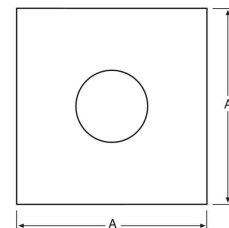

Fedkő-borító lemez flexibilis csőhöz

Flex top plate

Ø	A
80	500
100	500
110	500
120	500
125	500
130	500
140	500
150	500
160	500
180	500
200	500
220	500
250	500
300	500



Flex és kiegészítők

FLEX AND ACCESSORIES

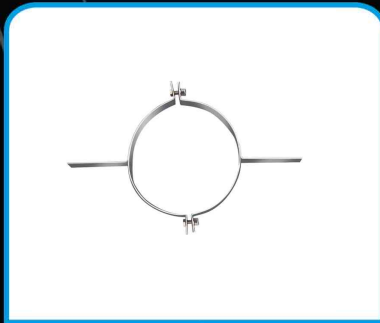

BFL316CBFLEX..

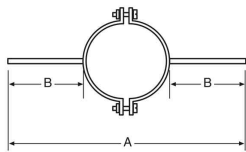

Felső tartóbilincs flexibilis csőhöz

Top clamp for flexible pipe

Ø	A	B
80	480	200
100	500	200
110	510	200
120	520	200
125	525	200
130	530	200
140	540	200
150	550	200
160	560	200
180	580	200
200	600	200
220	620	200
250	650	200
300	700	200



FLEXKIT..

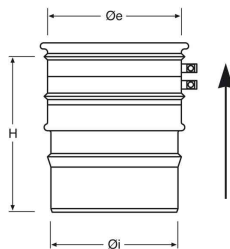

Merev-flex átalakító tömítőgyűrűvel és bilincsel, kondenzációs kazánhoz is 200 Pa

Flexadapter "Flexkit" to rigid male 200 Pa

Øe	Øi	H
80	78	180
100	98	180
110	108	165
120	118	165
130	128	165
140	138	165
150	148	165
160	158	165
-	-	-
-	-	-
-	-	-
-	-	-
-	-	-
-	-	-
-	-	-
-	-	-



FLEXKIT2..

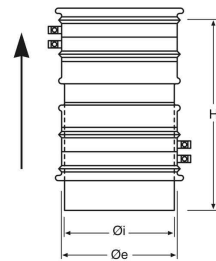

Flex-flex összekötő elem, szilikon tömítéssel és szorítóbilincsel kondenzációs kazánhoz is 200 Pa

Flex - flex joiner "Flexkit" with condensate diverter 200 Pa

Øe	Øi	H
80	78	180
100	98	180
110	108	165
120	118	165
130	128	165
140	138	165
150	148	165
160	158	165
-	-	-
-	-	-
-	-	-
-	-	-
-	-	-
-	-	-
-	-	-
-	-	-



Flex és kiegészítők

FLEX AND ACCESSORIES



FLEXKIT3..

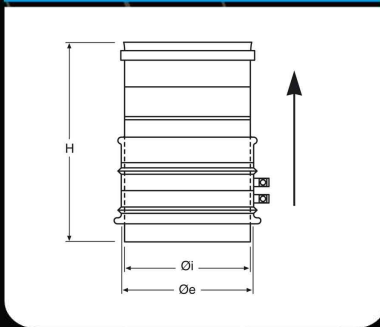

Flex-merev összekötő elem, szilikon tömítéssel és szorítóbilinccsel, kondenzációs kazánhoz is 200 Pa

Flexadapter "Flexkit" to rigid female 200 Pa



304EXPS..



Flexibilis béléscső AISI 304

Single wall flexible liner in stainless steel AISI 304



304EXDP..



Duplafalú, flexibilis béléscső AISI 304

Twin wall smooth inner surface flexible liner in stainless steel AISI 304

Øe	Øi	H
80	78	180
100	98	180
110	108	165
120	118	165
130	128	165
140	138	165
150	148	165
160	158	165
-	-	-
-	-	-
-	-	-
-	-	-
-	-	-
-	-	-

Øi	Øe	Lpl	Hpl	M	Lam	Ham	M.	Ldisp	Hdisp	M..
60	66	-	-	-	-	-	-	-	-	-
73	79	-	-	-	-	-	-	-	-	-
80	86	66	100	30	66	100	30	120	80	60
90	-	-	-	-	-	-	-	-	-	-
100	106	92	72	30	92	72	30	120	80	60
110	116	100	80	30	100	80	30	120	80	60
120	126	100	80	30	100	80	30	120	120	50
125	131	120	80	30	120	80	30	120	120	50
130	136	120	80	30	120	80	30	120	120	50
140	146	120	80	30	120	80	30	120	120	35
150	156	135	70	30	120	120	30	120	150	30
155	161	135	70	30	120	120	30	120	120	30
160	166	135	70	30	120	120	30	120	120	27
180	186	120	120	30	160	70	30	120	120	25
200	206	165	85	25	120	135	25	120	120	20
220	226	160	85	25	165	85	25	-	-	-
225	231	-	-	25	-	-	25	-	-	-
250	256	165	85	20	165	85	20	-	-	-
300	306	6	-	6	-	-	6	-	-	-
350	356	-	-	-	-	-	-	-	-	-
400	406	-	-	-	-	-	-	-	-	-

EXPO INOX



67.6

20



Expo Inox S.p.a.
Viale Artigianato 6
27020 Borgo San Siro (PV) ITALIA

tel. +39 0382 87237

fax +39 0382 87330

e-mail: info@expoinox.com

www.expoinox.com