

ACÉLA HÁZBAN

EXPO INOX hosszú ideje saválló acél gyártással és feldolgozással foglalkozik. Minden megkeresést pontos tervezés követ; termékeink innovatív technológiája, sokoldalúsága és az anyagok hosszú élettartama tesz minket képessé arra, hogy fejlett műszaki tartalommal, esztétikus termékeket nyújtsunk a legmagasabb minőségben. A rozsdamentes acél ideális az egyszerű vagy éppen összetettebb design megalkotására, belélliszkedve a meglévő környezetbe. Az acéllal történő tervezés az elvárt eredményt nyújtja vásárlóinknak, legyen szó akár a legkifinomultabb kérésről - ez a mi filozófiánk.

BUILDING WITH STAINLESS STEEL

EXPO INOX has been involved in stainless steel production for a long time. Every request is subjected to an accurate planning; the innovative techniques of our products, the multi purpose nature and long lasting characteristics of this material, enable us to propose advanced technical, aesthetical and design solutions of the highest quality. Stainless steel is ideal for linear and essential design creations, matching and respecting the environment in which it is placed. Design with stainless steel, give the customer the result he desires even to the most demanding requests: this is our main objective.

EXPO INOX



67.6

20





EDW25 - Duplafalú AISI 304 / AISI 304

EDW25 DOUBLE WALL AISI 304 / AISI 304



EEXTDP1C..

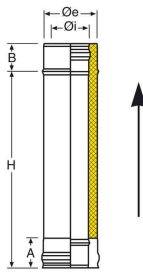

● DUPLAFALÚ SZIGETELT- 1 méteres
hosszelem AISI 304

Length 1 m double wall insulated in
AISI 304

Øi	Øe	H	A	B
80	130	940	65	54
100	150	940	65	54
130	180	940	65	54
150	200	940	65	54
180	230	940	65	54
200	250	940	65	54
250	300	940	65	54
300	350	940	65	54
350	400	940	65	54
400	450	940	65	54
450	500	940	65	54
500	550	940	65	54
550	600	940	65	54
600	650	940	65	54
650	700	940	65	54
700	750	940	65	54
750	800	940	65	54
800	850	940	65	54



EEXTDP5C..

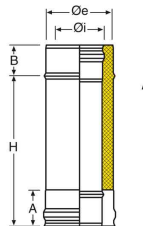

● cső DW inox 0.50 m DN 80/130 AISI
304 BA vastagság 0,4 mm

pipe DW inox 0.50 m DN 80/130 AISI
304 BA thickness 0,4 mm

Øi	Øe	H	A	B
80	130	440	65	54
100	150	440	65	54
130	180	440	65	54
150	200	440	65	54
180	230	440	65	54
200	250	440	65	54
250	300	440	65	54
300	350	440	65	54
350	400	440	65	54
400	450	440	65	54
450	500	440	65	54
500	550	440	65	54
550	600	440	65	54
600	650	440	65	54
650	700	440	65	54
700	750	440	65	54
750	800	440	65	54
800	850	440	65	54



EEXTDP2C..

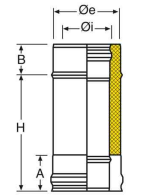

● cső DW inox 0.33 m DN 80/130 AISI
304 BA vastagság 0,4 mm

pipe DW inox 0.33 m DN80/130 AISI
304 BA thickness 0,4 mm

Øi	Øe	H	A	B
80	130	270	65	54
100	150	270	65	54
130	180	270	65	54
150	200	270	65	54
180	230	270	65	54
200	250	270	65	54
250	300	270	65	54
300	350	270	65	54
350	400	270	65	54
400	450	270	65	54
450	500	270	65	54
500	550	270	65	54
550	600	270	65	54
600	650	270	65	54
650	700	270	65	54
700	750	270	65	54
750	800	270	65	54
800	850	270	65	54



EDW25 - Duplafalú AISI 304 / AISI 304

EDW25 DOUBLE WALL AISI 304 / AISI 304



EEXTDP25C..

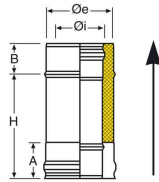

cső DW inox 0,25 m DN 80/130 AISI 304 BA vastagság 0,4 mm

pipe DW inox 0.25 m DN80/130 AISI 304 BA thickness 0,4 mm

Øi	Øe	H	A	B
80	130	190	65	54
100	150	190	65	54
130	180	190	65	54
150	200	190	65	54
180	230	190	65	54
200	250	190	65	54
250	300	190	65	54
300	350	190	65	54
350	400	190	65	54
400	450	190	65	54
450	500	190	65	54
500	550	190	65	54
550	600	190	65	54
600	650	190	65	54
650	700	190	65	54
700	750	190	65	54
750	800	190	65	54
800	850	190	65	54



EEXETDP4C..

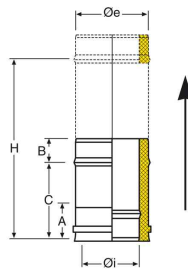

elem DW inox állítható fűstcső DN 80/130 AISI 304 BA vastagság 0,4 mm

element DW inox adjustable pipe DN80/130 AISI 304 BA thickness 0,4 mm

Øi	Øe	H	A	B	C
80	130	390	65	54	260
100	150	390	65	54	260
130	180	390	65	54	260
150	200	390	65	54	260
180	230	390	65	54	260
200	250	390	65	54	260
250	300	390	65	54	260
300	350	390	65	54	260
350	400	390	65	54	260
400	450	390	65	54	260
450	500	390	65	54	260
500	550	390	65	54	260
550	600	390	65	54	260
600	650	390	65	54	260
650	700	390	65	54	260
700	750	390	65	54	260
750	800	390	65	54	260
800	850	390	65	54	260



EEXGDP90C..

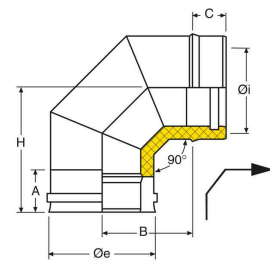

DUPLAFALÚ SZIGETELT- 90°os könyök

Elbow 90° TIG welded double wall insulated in AISI 304

Øi	Øe	H	A	B	C
80	130	160	65	100	54
100	150	180	65	120	54
130	180	190	65	130	54
150	200	200	65	140	54
180	230	215	65	155	54
200	250	225	65	165	54
250	300	250	65	190	54
300	350	275	65	215	54
350	400	321	65	261	54
400	450	367	65	307	54
450	500	392	65	332	54
500	550	417	65	357	54
550	600	442	65	382	54
600	650	467	65	407	54
650	700	492	65	432	54
700	750	517	65	457	54
750	800	542	65	482	54
800	850	567	65	507	54



EDW25 - Duplafalú AISI 304 / AISI 304

EDW25 DOUBLE WALL AISI 304 / AISI 304



EEXGDP45C..

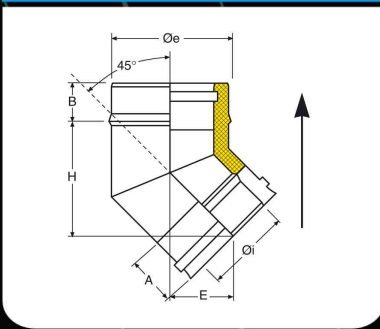

könyök DW inox 45° tig DN80/130 AISI 304 BA vastagság 0,4 mm

bend DW inox 45° tig DN80/130 AISI 304 BA thickness 0,4 mm



EEXGDP30C..

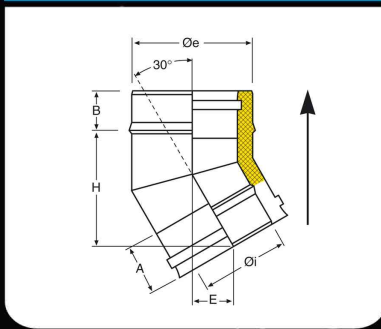

könyök DW inox 30° DN80/130 AISI 304 BA vastagság 0,4 mm

bend DW inox 30° DN80/130 AISI 304 BA thickness 0,4 mm



EEXGDP15C..

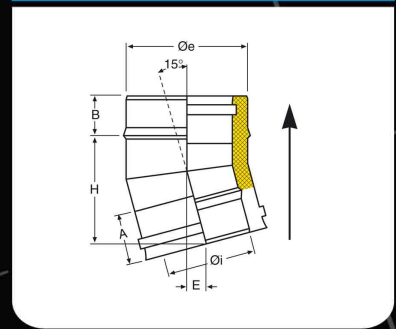

könyök DW inox 15° DN80/130 AISI 304 BA vastagság 0,4 mm

bend DW inox 15° DN80/130 AISI 304 BA thickness 0,4 mm

Øi	Øe	H	A	B	E
80	130	119	65	54	72
100	150	126	65	54	75
130	180	137	65	54	79
150	200	143	65	54	82
180	230	160	65	54	88
200	250	164	65	54	91
250	300	184	65	54	98
300	350	197	65	54	105
350	400	215	65	54	114
400	450	234	65	54	123
450	500	252	65	54	130
500	550	270	65	54	138
550	600	287	65	54	145
600	650	334	65	54	164
650	700	352	65	54	172
700	750	369	65	54	169
750	800	387	65	54	186
800	850	405	65	54	194

Øi	Øe	H	A	B	E
80	130	119	65	54	46
100	150	122	65	54	48
130	180	130	65	54	51
150	200	135	65	54	51
180	230	142	65	54	53
200	250	147	65	54	54
250	300	160	65	54	57
300	350	172	65	54	60
350	400	184	65	54	63
400	450	197	65	54	67
450	500	210	65	54	70
500	550	222	65	54	74
550	600	235	65	54	77
600	650	282	65	54	93
650	700	295	65	54	96
700	750	307	65	54	99
750	800	320	65	54	103
800	850	332	65	54	106

Øi	Øe	H	A	B	E
80	130	112	65	54	23
100	150	115	65	54	23
130	180	119	65	54	23
150	200	121	65	54	24
180	230	125	65	54	25
200	250	128	65	54	24
250	300	134	65	54	25
300	350	141	65	54	26
350	400	147	65	54	27
400	450	154	65	54	28
450	500	160	65	54	29
500	550	167	65	54	30
550	600	173	65	54	31
600	650	214	65	54	36
650	700	220	65	54	37
700	750	225	65	54	38
750	800	233	65	54	39
800	850	240	65	54	40



EDW25 - Duplafalú AISI 304 / AISI 304

EDW25 DOUBLE WALL AISI 304 / AISI 304



EEXRTDPC..

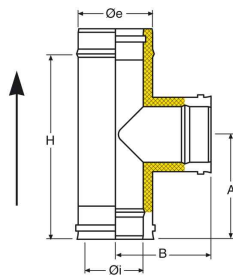

● DUPLAFALÚ SZIGETELT- 90° os Tidom AISI 304

90° tee double wall insulated in AISI 304

Øi	Øe	H	A	B
80	130	440	242	140
100	150	440	242	150
130	180	440	242	165
150	200	440	242	175
180	230	440	242	190
200	250	440	242	200
250	300	440	242	225
300	350	490	267	250
350	400	588	322	275
400	450	710	380	300
450	500	710	380	325
500	550	760	405	350
550	600	810	430	375
600	650	810	430	400
650	700	840	445	425
700	750	890	470	450
750	800	940	495	475
800	850	990	520	500



EEXRTIC..

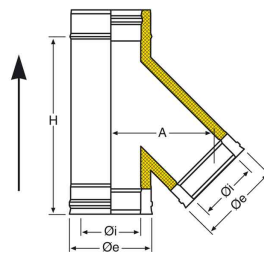

● DUPLAFALÚ SZIGETELT- 45° os T idom AISI 304

45° tee double wall insulated in AISI 304

Øi	Øe	H	A
80	130	350	196
100	150	390	215
130	180	390	241
150	200	440	258
180	230	470	273
200	250	515	300
250	300	560	344
300	350	640	386
350	400	883	496
400	450	940	515
450	500	1020	542
500	550	1020	593
550	600	1092	653
600	650	1122	696
650	700	1164	739
700	750	1280	781
750	800	1290	824
800	850	1342	867



EEXRTDPCU..

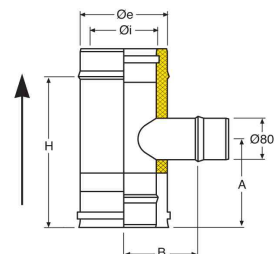

● DUPLAFALÚ SZIGETELT- 90° -os szűkítő T idom Ø 80mm bekötéssel

90° reducing tee to single wall Ø 80 mm double wall insulated in AISI 304

Øi	Øe	H	A	B
80	130	190	123	90
100	150	190	123	100
130	180	190	123	115
150	200	190	123	125
180	230	190	123	140
200	250	190	123	150
250	300	190	123	175
300	350	190	123	200



EDW25 - Duplafalú AISI 304 / AISI 304

EDW25 DOUBLE WALL AISI 304 / AISI 304



EEXP..

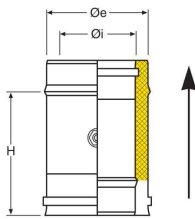

● DUPLAFALÚ SZIGETELT- Füstgáz ellenőrző idom

Element for smoke test with threaded sleeve double wall insulated in AISI 304

Øi	Øe	H
80	130	190
100	150	190
130	180	190
150	200	190
180	230	190
200	250	190
250	300	190
300	350	190
350	400	190
400	450	190
450	500	190
500	550	190
550	600	190
600	650	190
650	700	190
700	750	190
750	800	190
800	850	190



EEXPFT..

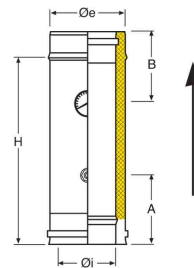

● DUPLAFALÚ SZIGETELT- Füstgáz és hőmérséklet ellenőrző idom lap elemmel

Element for smoke and temperature test with threaded sleeve double wall insulated in AISI 304

Øi	Øe	H	A	B
80	130	440	160	160
100	150	440	160	160
130	180	440	160	160
150	200	440	160	160
180	230	440	160	160
200	250	440	160	160
250	300	440	160	160
300	350	440	160	160
350	400	440	160	160
400	450	440	160	160
450	500	440	160	160
500	550	440	160	160
550	600	440	160	160
600	650	440	160	160
650	700	440	160	160
700	750	440	160	160
750	800	440	160	160
800	850	440	160	160



EEXTMFCF..

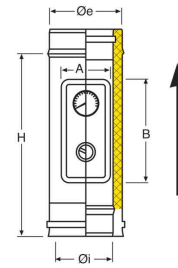

● DUPLAFALÚ SZIGETELT- Füstgáz és hőmérséklet ellenőrző idom lap elemmel AISI 304

Element with plate for smoke and temperature test with threaded sleeve double wall insulated in AISI 304

Øi	Øe	H	A	B
80	130	440	113	190
100	150	440	113	190
130	180	440	113	190
150	200	440	113	190
180	230	440	113	190
200	250	440	113	190
250	300	440	185	280
300	350	440	185	280
350	400	440	185	280
400	450	440	185	280
450	500	440	185	280
500	550	440	185	280
550	600	440	185	280
600	650	440	185	280
650	700	440	185	280
700	750	440	185	280
750	800	440	185	280
800	850	440	185	280



EDW25 - Duplafalú AISI 304 / AISI 304

EDW25 DOUBLE WALL AISI 304 / AISI 304



EEXTSIDPC..

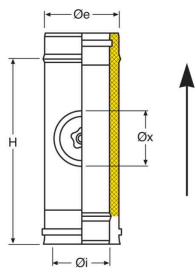

● DUPLAFALÚ SZIGETELT- Egyenes ellenőrző idom kör alakú ellenőrző nílással

Inspection length with round door double wall insulated in AISI 304

Øi	Øe	Øx	H
80	130	80	270
100	150	100	270
130	180	130	270
150	200	150	270
180	230	180	440
200	250	200	440
250	300	200	440
300	350	200	440
350	400	200	440
400	450	200	440
450	500	200	440
500	550	200	440
550	600	200	440
600	650	200	440
650	700	200	440
700	750	200	440
750	800	200	440
800	850	200	440



EEXDPERC..

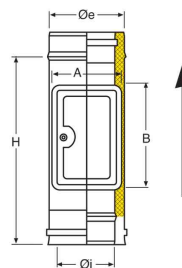

● DUPLAFALÚ SZIGETELT- Ellenőrző idom negatív nyomásra

Inspection length with square door double wall insulated in AISI 304

Øi	Øe	H	A	B
80	130	440	113	190
100	150	440	113	190
130	180	440	113	190
150	200	440	113	190
180	230	440	113	190
200	250	440	113	190
250	300	440	185	280
300	350	440	185	280
350	400	440	185	280
400	450	440	185	280
450	500	440	185	280
500	550	440	185	280
550	600	440	185	280
600	650	440	185	280
650	700	440	185	280
700	750	440	185	280
750	800	440	185	280
800	850	440	185	280

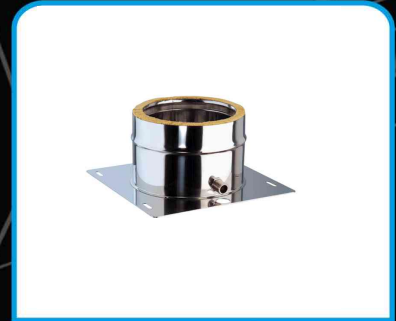

EEXPIASTRC..

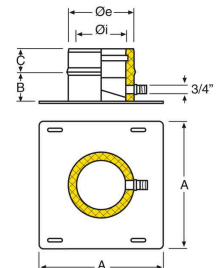

● lap DW inox indító idom kondenzelvezetővel DN 80/130 AISI 304 BA vastagság 0,4 mm

plate DW inox base plate with drain plug DN 80/130 AISI 304 BA thickness 0,4 mm

Øi	Øe	A	B	C
80	130	230	100	54
100	150	250	100	54
130	180	280	100	54
150	200	300	100	54
180	230	330	100	54
200	250	350	100	54
250	300	400	100	54
300	350	450	100	54
350	400	500	100	54
400	450	550	100	54
450	500	600	100	54
500	550	650	100	54
550	600	700	100	54
600	650	750	100	54
650	700	800	100	54
700	750	850	100	54
750	800	900	100	54
800	850	950	100	54



EDW25 - Duplafalú AISI 304 / AISI 304

EDW25 DOUBLE WALL AISI 304 / AISI 304



EXCSDP..

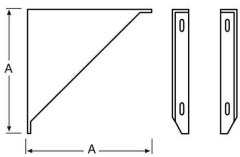

● DUPLAFALÚ SZIGETELT- Fali konzol (párban)

Cantilever brackets (pair) double wall insulated

Ø	A
80	230
100	250
130	280
150	300
180	330
200	350
250	400
300	450
350	500
400	550
450	600
500	650
550	700
600	750
650	800
700	850
750	900
800	950



EEXPIASIC..

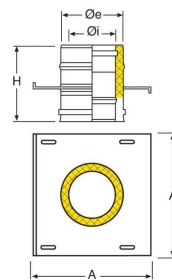

● DUPLAFALÚ SZIGETELT- Köztes súlytartó lemez

Intermediate anchor plate double wall insulated in AISI 304

Øi	Øe	H	A
80	130	190	230
100	150	190	250
130	180	190	280
150	200	190	300
180	230	190	330
200	250	190	350
250	300	190	400
300	350	190	450
350	400	190	500
400	450	190	550
450	500	190	600
500	550	190	650
550	600	190	700
600	650	190	750
650	700	190	800
700	750	190	850
750	800	190	900
800	850	190	950



EEXPIASICDM..

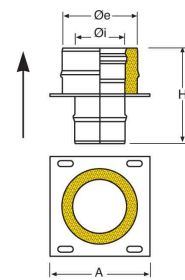

● DUPLAFALÚ SZIGETELT- Köztes lemez konzolos szereléshez - egyfalú/szigetelt

Intermediate anchor plate single - double wall insulated in AISI 304

Øi	Øe	H	A
80	130	190	180
100	150	190	200
130	180	190	230
150	200	190	250
180	230	190	280
200	250	190	300
250	300	190	350
300	350	190	400
350	400	190	450
400	450	190	500
450	500	190	550
500	550	190	600
550	600	190	650
600	650	190	700
650	700	190	750
700	750	190	800
750	800	190	850
800	850	190	900



EDW25 - Duplafalú AISI 304 / AISI 304

EDW25 DOUBLE WALL AISI 304 / AISI 304



EEXTAPDP4C..

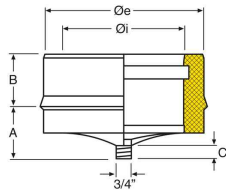

DW inox kondenz elvezető DN 80/130
AISI 304 BA vastagság 0,4 mm

DW inox condense drain DN80/130
AISI 304 BA thickness 0,4 mm

Øi	Øe	A	B	C
80	130	65	54	12
100	150	65	54	12
130	180	65	54	12
150	200	65	54	12
180	230	65	54	12
200	250	65	54	12
250	300	65	54	12
300	350	65	54	12
350	400	65	54	12
400	450	65	54	12
450	500	65	54	12
500	550	65	54	12
550	600	65	54	12
600	650	65	54	12
650	700	65	54	12
700	750	65	54	12
750	800	65	54	12
800	850	65	54	12



EEXTC..

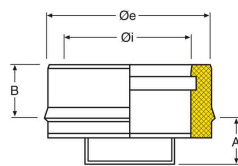

DW inox T sapka DN 80/130 AISI
304 BA vastagság 0,4 mm

DW inox tee cap DN80/130 AISI 304
BA thickness 0,4 mm

Øi	Øe	A	B
80	130	55	54
100	150	55	54
130	180	55	54
150	200	55	54
180	230	55	54
200	250	55	54
250	300	55	54
300	350	55	54
350	400	55	54
400	450	55	54
450	500	55	54
500	550	55	54
550	600	55	54
600	650	55	54
650	700	55	54
700	750	55	54
750	800	55	54
800	850	55	54



EEXCCDPC..

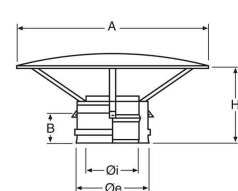

DUPLAFALÚ SZIGETELT- Esővédő
sapka

Rain cap double wall insulated in
AISI 304

Øi	Øe	H	A	B
80	130	190	265	65
100	150	190	265	65
130	180	230	320	65
150	200	230	320	65
180	230	250	400	65
200	250	250	400	65
250	300	270	500	65
300	350	270	600	65
350	400	300	720	65
400	450	300	720	65
450	500	330	850	65
500	550	330	850	65
550	600	330	900	65
600	650	360	1150	65
650	700	370	1250	65
700	750	380	1350	65
750	800	390	1400	65
800	850	400	1450	65



EDW25 - Duplafalú AISI 304 / AISI 304

EDW25 DOUBLE WALL AISI 304 / AISI 304



EEXTADPC..

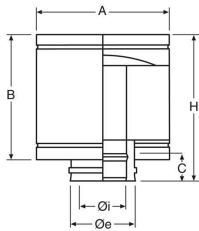

● DUPLAFALÚ SZIGETELT- Viharsapka

Anti downdraught cowl double wall insulated in AISI 304

Øi	Øe	H	A	B	C
80	130	325	222	165	65
100	150	375	260	200	65
130	180	405	303	200	65
150	200	405	310	250	65
180	230	405	370	250	65
200	250	405	418	250	65
250	300	405	468	310	65
300	350	405	530	310	65
350	400	405	700	330	65
400	450	405	800	330	65
450	500	405	900	330	65
500	550	405	1000	360	65
550	600	435	1000	360	65
600	650	435	1000	360	65
650	700	435	1200	360	65
700	750	475	1250	400	65
750	800	475	1300	400	65
800	850	475	1400	400	65



EEXTCDPC..

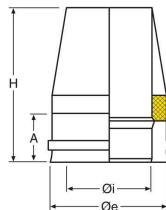

● záró DW inox záró kúp DN 80/ 130 AISI 304 BA

terminal DW inox venturi cone DN80/DN130 AISI 304 BA

Øi	Øe	H	A
80	130	200	65
100	150	200	65
130	180	200	65
150	200	200	65
180	230	200	65
200	250	200	65
250	300	200	65
300	350	200	65
350	400	290	65
400	450	290	65
450	500	290	65
500	550	290	65
550	600	290	65
600	650	290	65
650	700	290	65
700	750	290	65
750	800	290	65
800	850	290	65



EEXRCIDP..

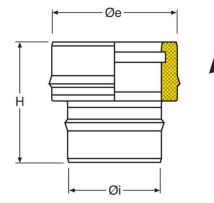

● DUPLAFALÚ SZIGETELT- Egyfalú/ szigetelt átalakító idom

Adaptor from single to double wall (boiler adaptor) double wall insulated in AISI 304

Øi	Øe	H
80	130	160
100	150	160
130	180	160
150	200	160
180	230	160
200	250	160
250	300	160
300	350	160
350	400	160
400	450	160
450	500	160
500	550	160
550	600	160
600	650	160
650	700	160
700	750	160
750	800	160
800	850	160



EDW25 - Duplafalú AISI 304 / AISI 304

EDW25 DOUBLE WALL AISI 304 / AISI 304



EEXGIUDMC..

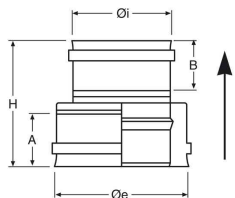

csatlakozó DW inox duplafalú- egyfalú
DN 80/130 AISI 304 BA vastagság 0,4
mm

connector DW inox double - single
DN80/130 AISI 304 BA thickness 0,4
mm

Øi	Øe	H	A	B
80	130	160	65	65
100	150	160	65	65
130	180	160	65	65
150	200	160	65	65
180	230	160	65	65
200	250	160	65	65
250	300	160	65	65
300	350	160	65	65
350	400	160	65	65
400	450	160	65	65
450	500	160	65	65
500	550	160	65	65
550	600	160	65	65
600	650	160	65	65
650	700	160	65	65
700	750	160	65	65
750	800	160	65	65
800	850	160	65	65



EXFASCAC..

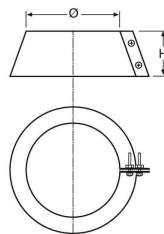

Esőgallér

Storm collar double wall insulated

Øi	Øe	H
80	130	100
100	150	100
130	180	100
150	200	100
180	230	100
200	250	100
250	300	100
300	350	100
350	400	100
400	450	100
450	500	100
500	550	100
550	600	100
600	650	100
650	700	100
700	750	100
750	800	100
800	850	100

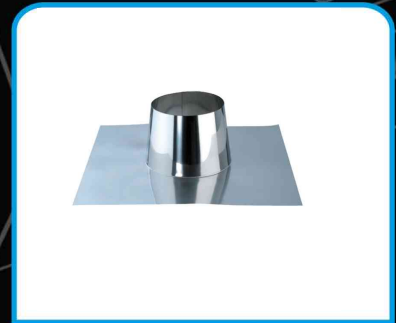

EXFALDPC..

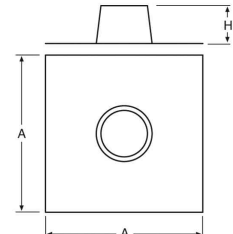

Tetőátvezető idom

Flat flashing double wall insulated

Øi	A	H
80	450	150
100	450	150
130	500	170
150	600	180
180	600	210
200	600	210
250	650	230
300	700	230
350	700	200
400	850	200
450	900	200
500	950	200
550	1100	200
600	1200	200
650	1300	200
700	1400	200
750	1500	200
800	1600	200



EDW25 - Duplafalú AISI 304 / AISI 304

EDW25 DOUBLE WALL AISI 304 / AISI 304



EXFALDR5C..

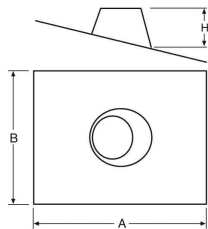

Állítható tetőátvezető idom 5°-30°

Adjustable flashing from 5° to 30°
double wall insulated

Ø	A	H
80	450	150
100	450	150
130	500	170
150	600	180
180	600	210
200	600	210
250	650	230
300	700	230
350	700	200
400	850	200
450	900	200
500	950	200
550	1100	200
600	1200	200
650	1300	200
700	1400	200
750	1500	200
800	1600	200



EXCOLC..

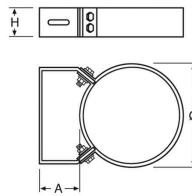

Fali távtartó

Wall bracket double wall insulated

Øi	Øe	A	B
80	130	40	50
100	150	40	50
130	180	40	50
150	200	40	50
180	230	40	50
200	250	40	50
250	300	40	50
300	350	40	50
350	400	100	50
400	450	100	50
450	500	100	50
500	550	100	50
550	600	100	50
600	650	100	50
650	700	100	50
700	750	100	50
750	800	100	50
800	850	100	50



EXDISC..

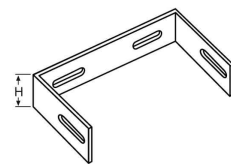

Fali távtartó

Extension for wall bracket double
wall insulated

Ø	H
80	50
100	50
110	50
120	50
125	50
130	50
140	50
150	50
160	50
180	50
200	50
220	50
250	50
300	50
350	50
400	50
450	50
500	50



EDW25 - Duplafalú AISI 304 / AISI 304

EDW25 DOUBLE WALL AISI 304 / AISI 304



EXFASDC..

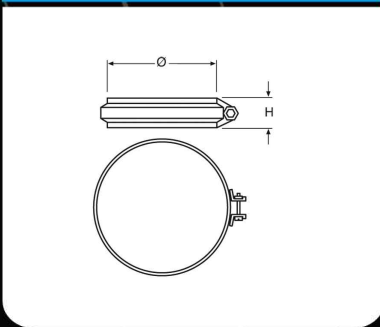

EXCOLTC..

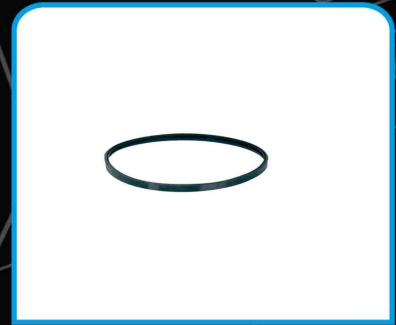
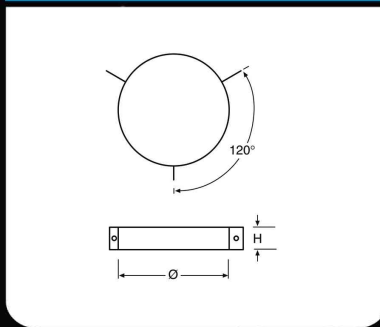

L316EX2GN..

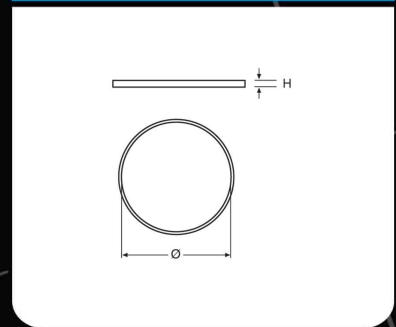

● DUPLAFALÚ SZIGETELT-
Szorítóbilincs

● Kábelrögzítő bilincs

● EGYFALÚ - Szilikon tömítőgyűrű

Locking band double wall insulated

Guy wire bracket double wall insulated

Seal black

Ø	H
130	30
150	30
180	30
200	30
230	30
250	30
300	30
350	30
400	30
450	42
500	42
550	42
600	42
650	42
700	42
750	42
800	42
850	42

Øi	Øe	H
80	130	40
100	150	40
130	180	40
150	200	40
180	230	40
200	250	40
250	300	40
300	350	40
350	450	40
400	500	40
450	550	40
500	600	40
550	-	-
600	-	-
650	-	-
700	-	-
750	-	-
800	-	-

Ø	H
80	10
100	10
110	10
120	10
125	10
130	10
140	10
150	10
160	10
180	10
200	10
220	10
250	10
300	10
350	10

EXPO INOX



67.6

20

EXPO INOX



67.6

20



Expo Inox S.p.a.
Viale Artigianato 6
27020 Borgo San Siro (PV) ITALIA

tel. +39 0382 87237

fax +39 0382 87330

e-mail: info@expoinox.com

www.expoinox.com